

FUNDAMENT F120/43

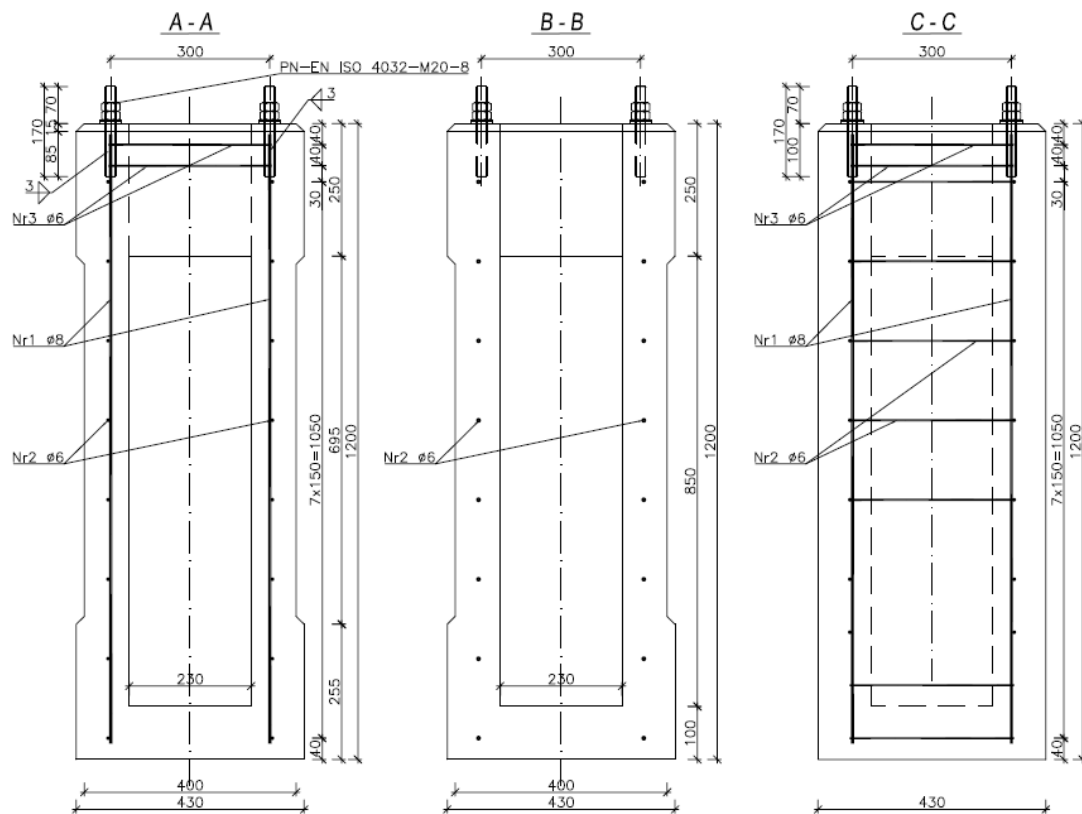

WIDOK Z GÓRY

